

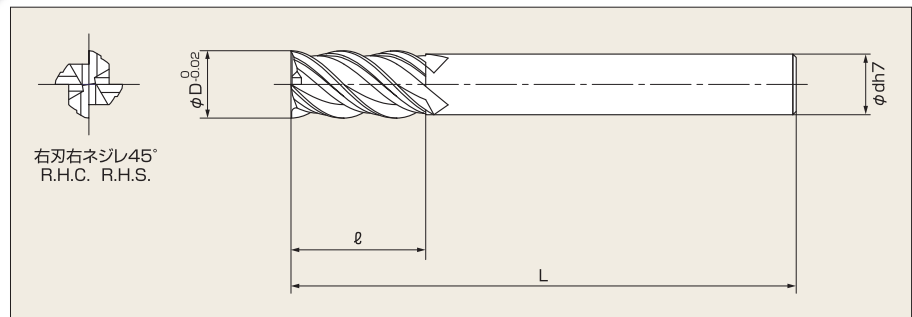

Cロング4枚刃スレンダー TIALNコート C-LSS4

SOLID CARBIDE SLENDER SHANK LONG IN NECK 4 FLUTE END MILL (TIALN)

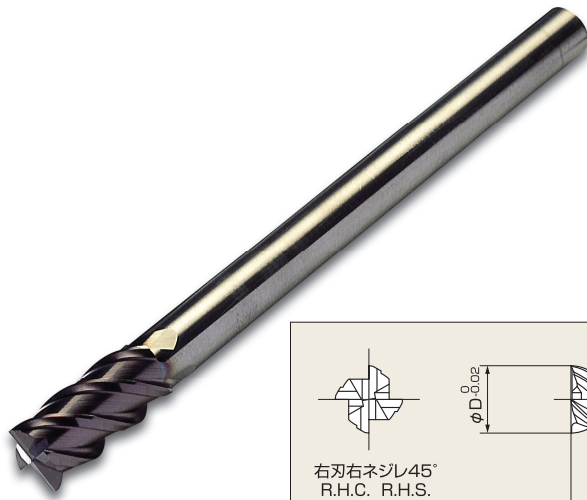

外径 (φD)	刃長 (ℓ)	全長 (L)	シャンク径 (φd)
4	10	90	3
6			4
8	15	105	6
10	20	120	8
12	25	135	10
16	30	150	14
18			16
20			18